

**ERITECH<sup>®</sup>**

# **CONTRACTOR TIPS**

FOR THE USE OF CADWELD<sup>®</sup> PRODUCTS

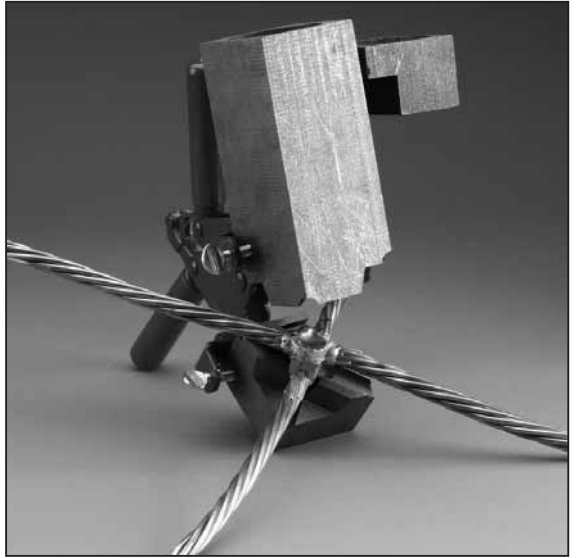

**ERICO<sup>®</sup>**

# TABLE OF CONTENTS

## CONTRACTOR TIPS FOR THE USE OF CADWELD® PRODUCTS

This manual contains a list of time-saving tips for contractors using CADWELD products. To use this guide, just look up the question you may have in the Table of Contents or the Index and then reference the informational tips. Making a CADWELD connection is often easier and less expensive than using crimp or bolted connections.

### CHECK LIST

Every job needs:

Mold(s) (with instruction sheets), flint ignitor or Control Unit, welding material\*, handle clamps, wire brush and torch.

In addition, some molds may need:

Packing for rebar molds, CADWELD mold sealer, mold cleaning tool, cable clamps, surface clamps, ground rod support clamps, etc.

\*If traditional welding material box is opened, check to be sure disks are still there.

## TABLE OF CONTENTS

**Question = Q**

**Page = P**

### Welding Procedure

Conductor and Surface Prep . . . . .P3  
General Welding Procedure . . . . .P4

### Connection Simplification

Sleeves and shim . . . . .Q1, P5  
Simplifying a GY or XB Connection .Q2, P6  
Fewer molds for the job . . . . .Q3, P7

### Tips For Making Connections

Wet or muddy conductors . . . . .Q4, P9  
Holes in the connection . . . . .Q5, P9  
Pin holes in the connection . . . . .Q6, P9  
Heating mold with a torch . . . . .Q7, P9  
Heating mold without a torch . . . . .Q7, P9  
Cable "burned up" . . . . .Q8, P10  
Leakage of welding material . . . . .Q9, P11  
Mold leakage . . . . .Q10, P11  
Clamp adjustment . . . . .Q11, P12  
Connections to steel . . . . .Q12, P12  
Steel surface clamps . . . . .Q13, P13  
Ground rod driving sleeves . . . . .Q14, P14  
Ground rod splices . . . . .Q15, P14  
Mold Life . . . . .Q16, P15  
CADWELD® PLUS . . . . .Q17, P16

Small tap wires . . . . .Q18, P16  
Cable sleeve . . . . .Q19, P16  
Solid conductor . . . . .Q20, P17  
No flint ignitor . . . . .Q21, P17  
Starting the reaction . . . . .Q21, P17  
Flint ignitors . . . . .Q22, P17  
300 g, 400 g & 500 g CADWELD PLUS Q23, P17  
Welding to copper surface . . . . .Q24, P18  
Connection of large conductors . . . . .Q25, P18  
Indoor connections . . . . .Q26, P19

### General Information

Price key . . . . .Q27, P20  
Wear plates . . . . .Q28, P20  
Split crucible . . . . .Q29, P20  
Heavy Duty . . . . .Q30, P21  
Welding material alloys . . . . .Q31, P21  
Welding material sizes . . . . .Q32, P22  
Ground rod connections . . . . .Q33, P22  
Reinforcing bar connections . . . . .Q34, P22  
Difference between connections . . . . .Q35, P23  
Different manufacturers materials . . . . .Q36, P24  
Threaded and Plain ground rods . . . . .Q37, P24  
Mold Clips . . . . .Q38, P24  
Handle Clamps & Frames . . . . .Q39, P25  
Ground rod diameters . . . . .Q40, P25

**Index** . . . . .P26 & P27



# CONNECTION SIMPLIFICATION

## Conductor and Surface Preparation

### 1. Preparation of Cable

- a. Conductors should be clean, shiny and dry to help ensure a good weld.
- b. Corrosion must be cleaned from conductors with an ERICO® T313 card cloth brush or a T314 cable cleaning brush. Keep tools clean to avoid contamination.
- c. Oil and/or grease should be removed from conductors.
- d. Wet conductors must be dried with an ERICO T111 torch head (fits on all standard 14 and 16 ounce propane bottles).
- e. Bent conductors (or conductors which have been “bird-caged”) can prevent the mold from closing tightly, which can cause leaks. To prevent deforming of the cable ends, use a cable cutter whenever possible.
- f. ERICO B265 cable clamps should be used for cables under tension. This keeps the cable from springing the mold open or being pulled out during welding.

### 2. Preparation of Ground Rods

- a. Ground rod ends that have been mushroomed by driving must be cut off as they will hold the mold open and cause leakage during the welding procedure.
- b. Ground rod must be clean, shiny and dry to help ensure a good weld.
- c. Corrosion must be removed as it may cause porosity in the weld.
- d. Ground rod splices require a B120 clamp.

### 3. Preparation of Steel Surfaces

- a. Welding surface must be cleaned bright and dried.
- b. Surface should be ground or filed using a course file or an ERICO T321 rasp. Keep tool clean to avoid contamination.
- c. If a grinder is used, use only a wheel that is self-cleaning and organically bonded, leaving no residue to contaminate the bonding surface.

### 4. Preparation of Rebar

- a. Rebar welding surface should be clean, shiny and dry to help ensure a good weld.
- b. If the rebar has surface corrosion protection (epoxy coating), it needs to be removed before making the connections.
- c. Corrosion and mill scale must be removed prior to making a weld. Use a course file or an ERICO T321 rasp. Keep tool clean to avoid contamination.
- d. Packing is required for most cable to rebar connections.
- e. Locking pliers are required to support mold for GR, GT, NC and ND connections.

# CONNECTION SIMPLIFICATION

## General Welding Procedure

1. Check the following
  - a. Mold is correct for the conductor size and application. Do not modify molds.
  - b. Welding material indicated on mold tag is available. Use only CADWELD® welding material with CADWELD molds.
  - c. Handle clamp and/or frame is attached to the mold and properly adjusted.
  - d. Flint ignitor or CADWELD® PLUS Control Unit is in working order.
2. Make sure mold is clean and dry and is in good condition. Dry the mold by heating with torch to about 250° F (120° C).
3. Position mold on conductor and/or against surface following appropriate instruction sheet provided with mold.
4. Close mold. Lock tightly with handle clamps / frame toggles.
5. Igniting Welding Material
  - a. Traditional CADWELD
    - i) Insert the steel disk into the crucible with concave side up to help ensure the disk seats properly and completely covers the tap hole.
    - ii) Dump the welding material into the crucible being careful not to upset the disk.
    - iii) Tap the tube to loosen starting material. Place approximately 1/2 of the starting material on top of the welding material, close the lid and place remaining starting material into the opening on top of the mold cover.
    - iv) Aiming the flint ignitor from the side, ignite the starting material in the mold cover opening in the top. Withdraw the ignitor quickly to prevent fouling.
  - b. CADWELD PLUS
    - i) Insert CADWELD PLUS package into the mold
    - ii) Attach the control unit termination clip to the ignition strip and make sure the termination clip is pushed all the way to the black mark on the strip.
    - iii) Press and hold the Control Unit button and wait for ignition.
6. Allow approximately 30 seconds for completion of the reaction and solidification of weld metal.
7. Open and remove the mold. Use care to prevent chipping the mold.
8. Remove expended CADWELD PLUS steel cup, if applicable, and clean mold using ERICO® T394 natural bristle brush or soft cloth.



# CONNECTION SIMPLIFICATION

**QUESTION 1:** I have several 4/0 molds in stock but now I have a small job using 2/0. Can I shim the smaller cable to fit the mold?

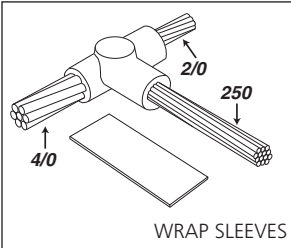

**ANSWER 1a:** You can often shim one or two cable sizes to fit a larger mold. Use a wrap sleeve, CADWELD® Part No. **B140A**. Wrap the shim around each cable to build it up to a 4/0 size. Then use the 4/0 molds to make the connection. We recommend that you keep a package of wrap sleeves handy.

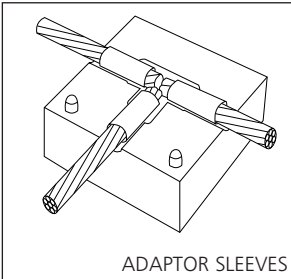

**ANSWER 1b:** Use an adaptor sleeve which is sized for specific cables to build up 2/0 to fit the 4/0 mold. Select sleeve Part No. **B1332Q** for this example. Adaptor sleeves cost more but they take less time.

## ADAPTOR SLEEVE SELECTION GUIDE

### CABLE SIZE

CONCENTRIC STRAND	SOLID	USE SLEEVE PART NO.	USE IN MOLD FOR
---	#6	B1331L	#4
#6	---	B112	#2
#4	#3 or #4	B1331V	#2
#3 or #4	#2	B1331Y	#1
#2	#1	B1332C	1/0
#1	1/0	B1332G	2/0
1/0 or #1	2/0	B1332L	3/0
2/0 or 3/0	3/0	B1332Q	4/0

## CONNECTION SIMPLIFICATION

**QUESTION 2:** The last time I had to make a through connection to the side of a ground rod, the three-piece mold was difficult to use because of its complex frames and toggles. Is there a simpler approach?

**ANSWER 2:** For a through connection to the side of a ground rod, try the 2-piece GY mold from ERICO®. This mold uses an L160 or L159 handle (the same clamps used for the majority of connections). It is less expensive and a lot easier to use.

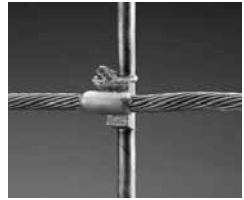
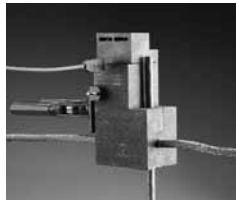

We have a similar solution for an X (cross) connection – instead of a complicated XBM or XBV mold – try the XBQ or XBZ mold. They make the same connection, are less expensive and save time.



We will be happy to help you find the right solution and recommend a connection that would meet your needs and potentially save you time and money.

Please see the answers to Question 3 for further information.



## CONNECTION SIMPLIFICATION

**QUESTION 3:** ERICO® makes so many different CADWELD® molds. Which molds are the most versatile?

**ANSWER 3a:** Use **Type PT** molds on conductor sizes up to 4/0. This one mold type can be used to make splices, "T's" and "X's", in addition to parallels.

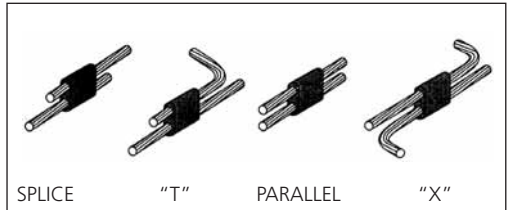

**ANSWER 3b:** When a splice is required, several different mold types may be used. For instance, a splice can be made using the same mold as other connections like a **Type TA**. Just center the ends of the cable to be spliced under the tap hole of the mold and use a short length of cable (about 3 inches) in the tap cable hole. Be careful to center the cable ends for the splice in the center of the mold.

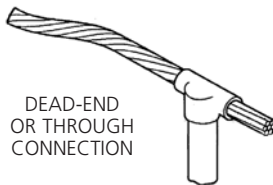

**ANSWER 3c:** For ground rods, use **Type GT** through cable connections. When the cable dead-ends at the ground rod, just let it extend past the rod 2" (through the mold) when making the connection.

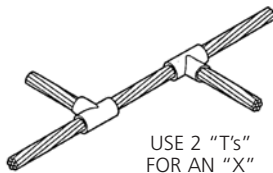

**ANSWER 3d:** When a lot of "T's" and a few "X's" are required on a job, use two "T's" about 2" apart to make the "X".

# CONNECTION SIMPLIFICATION

## QUESTION 3 (continued)

**ANSWER 3e:** When several cable-to-ground rod connections are shown on the print, use a **Type GT** mold to connect a through cable (or two cables from opposite directions) to the top of the rod. Then use a **Type TA** mold to connect the other cables to the first cable. Electrically, this is equivalent to that shown on the print.

### GROUND ROD CONNECTIONS

When the construction print shows several cables to a ground rod, several methods can be utilized to achieve the required electrical path.

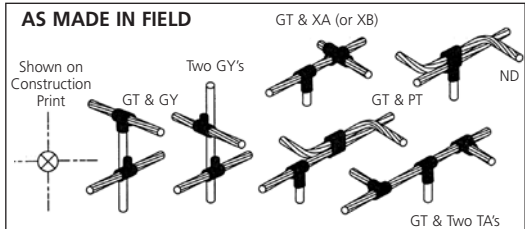
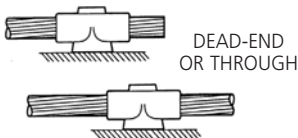
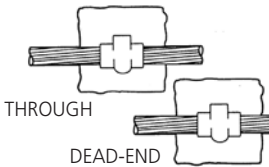
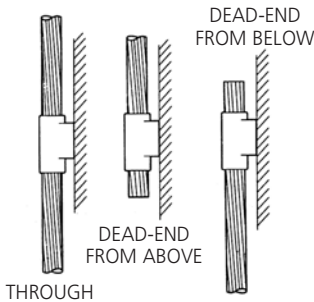

**ANSWER 3f:** When making connections of vertical cable to a vertical steel surface, a **Type VV** mold can be used for a through cable, a dead-end cable from above or a dead-end cable from below.

**ANSWER 3g:** When making connections of horizontal cable to a vertical steel surface, a **Type VG** or **VT** mold can be used for a through cable or a dead-end cable.

**ANSWER 3h:** When making connections of horizontal cable to a horizontal steel surface, a **Type HC** or **HT** mold can be used for a through cable or a dead-end cable.





## TIPS FOR MAKING CONNECTIONS

**QUESTION 4:** How do I clean the conductors when they are wet and muddy?

**ANSWER:** When the conductor is wet and muddy, first heat the conductor with a torch to dry all the moisture. Wiping the conductor with a cloth before heating helps to remove the mud. Second, tap the conductor to knock out as much dirt as possible. Finally, use a wire brush to clean the ends of the conductor and about 2 inches along the length of the conductor.

---

**QUESTION 5:** Sometimes, I get holes in the riser even after I have been using the mold and it is hot. What can I do?

**ANSWER 5a:** Holes in the riser can be caused by contamination on the cables or the surface if welding to steel. If there is oil or another substance which burns, a black material can usually be seen in the holes and around the weld. Moisture can also cause holes in the finished connection. See question 10 for further discussion.

**ANSWER 5b:** Holes in the riser can also be caused by excessive galvanizing when welding to a galvanized surface. If this occurs, remove a little more galvanizing at the area of the weld before making the next weld. This can be done with a file or a scraper.

---

**QUESTION 6:** I make good looking CADWELD® connections most of the time, but the first one I make each morning doesn't look as good. It has small pin holes in the riser or is silver in color. What can I do to improve that first mold connection?

**ANSWER:** Heat the mold (to above the boiling point of water) before using it each day. It only takes a couple of minutes using a hand-held propane torch. The graphite absorbs moisture from the atmosphere overnight. Making the first connection without heating the mold causes the moisture to turn to steam, some of which becomes trapped in the welding material.

---

**QUESTION 7:** I do heat the mold but still have the holes on the first connection. I know there is moisture in the mold because I can see the moisture come out as I am heating the mold. I heat the mold until it is nice and warm. What's wrong?

**ANSWER:** The moisture you are seeing coming out of the mold is actually moisture from the torch flame condensing on the cold mold (the product of combustion is water). You are therefore adding moisture to the mold as you begin heating it. This can't be prevented. It is therefore necessary to heat the mold to a high enough temperature to drive all the moisture out. It is hot enough when a drop of water sizzles on the mold. Having the mold this hot also provides another benefit - if there is moisture on the conductors, a hot mold will dry some of the moisture as the welding preparation takes place.

## TIPS FOR MAKING CONNECTIONS

**QUESTION 8:** The other day when I opened the mold, the cable was “burned up”. Was the “shot” (welding material) too hot causing it to burn up the cable?

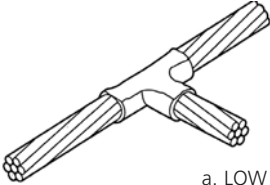

a. LOW FILL

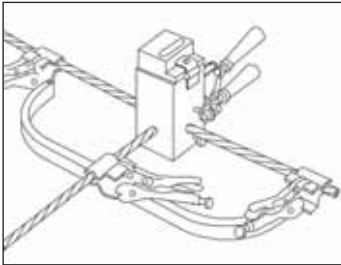

b. B265

**ANSWER:** What you experienced was not the cable being “burned up”. When a CADWELD® connection is being made, the molten metal from the reaction melts the cable in the weld cavity.

The resulting void in the connection can be the result of either of the following:

- a. If molten metal leaks from the mold, not enough material remains in the mold to fill the weld cavity. If the mold was properly closed and it still leaked, it may be worn and in need of replacement.
- b. If there is tension on the cable, even slight tension, the cable is pulled apart. This creates a larger void than can be filled with the welding material. Use cable clamp **B265** to hold the cables in place during the welding process.
- c. It is also important to use a pair of locking pliers to support the mold on a ground rod connection during the connection process. As the molten weld metal burns through the cable, the mold may slide down the rod without them.



## TIPS FOR MAKING CONNECTIONS

**QUESTION 9:** Sometimes molten metal leaks out of the mold around the cable strands, especially on 4/0, 7 strand cable. Is my mold defective?

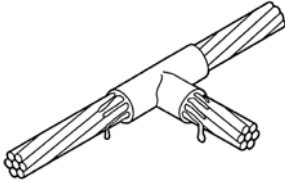

**ANSWER:** This is a common occurrence, especially after the mold has been used 15 to 20 times and the cable mold openings become worn. After the mold has been locked on the cables, apply a ring of CADWELD® T403 Mold Sealer around the cable where it enters the mold. Don't force it into the mold! If it gets in the weld cavity, the molten metal will cause it to burn and give off gases which can cause an improper weld or spattering of molten welding material.

**QUESTION 10:** The welding material leaks around the cable strands, especially when I use 4/0 7 strand cable. Can I pack mud to stop the leakage?

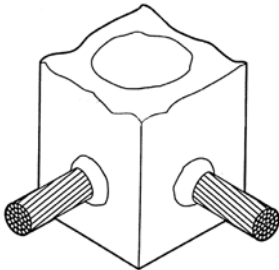

**ANSWER:** NO! Neither mud nor anything else containing water or oil should ever be used. CADWELD T403 Mold Sealer packed around the conductors AFTER the mold handles have been closed and locked will usually stop the leakage. However, after the mold wears and the cable opening becomes enlarged, the difference between the mold opening and the cable diameter may be too great for the mold sealer to do its job. A new mold will then be required.

When applying Mold Sealer, never allow it to be forced into the weld cavity. It will cause poor welds. See QUESTION 9.

## TIPS FOR MAKING CONNECTIONS

**QUESTION 11:** My mold doesn't close tight enough even though the handles lock. What can I do?

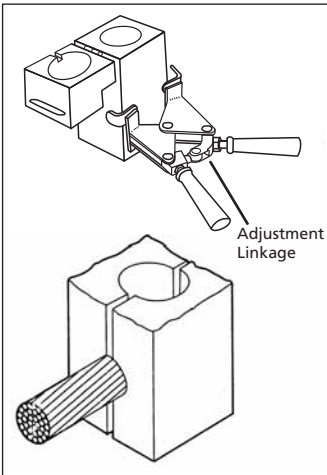

**ANSWER 11a:** The first thing to check is the adjustment of the handles, especially if the handles are new. Just in front of the grips is the adjustment linkage. Remove the key and pin. Turn the linkage counterclockwise to tighten the locking action and clockwise to loosen the locking action. Test the locking action and then replace the pin and key.

**ANSWER 11b:** Check the conductors at the mold cable opening to make sure that you are using the correct mold for the cable. Too large a cable will hold the mold open.

**ANSWER 11c:** Check the mold parting line. Make sure some foreign object isn't caught in the parting line.

**QUESTION 12:** When I try to make a connection to a steel surface sometimes it does not "stick" to the steel or, if it does, a light tap with a hammer knocks it off. Is there a problem with the welding material?

**ANSWER:** There is no problem with the welding material. This issue is caused by one of the following:

- The steel surface is not properly prepared. A file, rasp or grinder using an ERICO® approved wheel must be used to clean the steel surface to "bright metal". Brushing the surface is not sufficient. If the surface is heavily galvanized, the galvanizing at the area of the weld must be removed.
- The cable may not be positioned properly in the mold. When the cable dead-ends at the connection, the cable end must be positioned as shown on the instructions supplied with each mold. Positioning the cable end too far into the mold may restrict the flow of the molten welding material resulting in an improper connection.



# TIPS FOR MAKING CONNECTIONS

**QUESTION 13:** When welding to a steel surface, is there an easy way to hold the mold tight to the surface?

**ANSWER:** While there is no one solution, ERICO® offers several clamps for different situations:

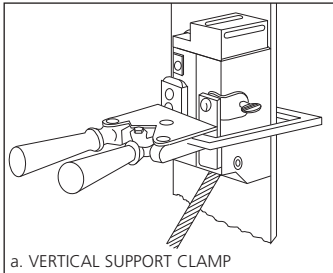

- a. When welding to an I beam column, the CADWELD® Vertical Support Clamp is available. The part numbers are **B134** for the **L160** handle (fits "C" Price Key molds) and **B135** for the **L159** handle (fits "D" Price Key molds). The clamp is easily attached to your existing CADWELD MINI EZ Change Handle Clamp.

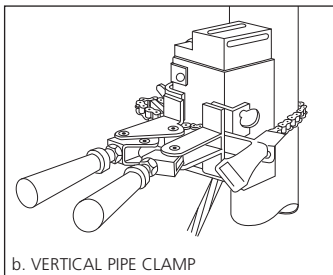

- b. If welding to a vertical pipe, the CADWELD Pipe Clamp works well. It is a single unit incorporating both the pipe clamp and the handle clamp. Part numbers for the different mold sizes and applications are as follows:

CLAMP PART NO	FITS MOLD PRICE KEYS	FOR THE FOLLOWING CONNECTION TYPES	PIPE
B159V	D & F	VS, VF, VB & VV	VERTICAL
B160V	C & R	VS, VF, VB & VV	VERTICAL
B159VT	D & F	VT	VERTICAL
B160VT	C & R	VT	VERTICAL
B159H	D & F	HA, HS, HC & HT	HORIZONTAL
B160H	C & R	HA, HS, HC & HT	HORIZONTAL

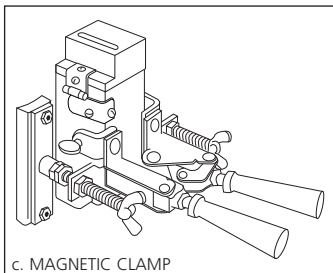

- c. For large flat surfaces or large diameter steel tanks, the CADWELD Magnetic Clamp is the answer when using vertically split molds. It is a combination Handle Clamp and Magnetic Clamp, part number **B396** for "C" & "R" Price Key molds and **B159M** for "D" & "F" Price Key molds.

## TIPS FOR MAKING CONNECTIONS

**QUESTION 14:** Every time I drive a ground rod, I have to cut off the top of the rod before my mold will fit on. How can I save time on this connection?



**ANSWER:** Time savings is achieved when using a driving sleeve or ERITECH® ground rod driver. If using a threaded rod, use the screw coupling and drive stud when driving the rod. For a plain rod, either steel or copperbonded, use the CADWELD® driving sleeve listed below.

### GROUND ROD DRIVING SLEEVES\*

GROUND ROD SIZE	PART NO.
1/2" COPPERCLAD OR STEEL	B137-14
5/8" COPPERCLAD	B137-16
5/8" STEEL	B137-31
3/4" COPPERCLAD	B137-18
3/4" STEEL	B137-33
1" COPPERCLAD	B137-22
1" STEEL	B137-37

\*FOR PLAIN (NOT THREADED) RODS ONLY

**QUESTION 15:** When making Type GB ground rod splices, I have a hard time positioning the mold correctly on the rods. Any suggestions?

**ANSWER:** Use the CADWELD **B120** clamp. This clamp not only supports the rod but also properly positions and supports the mold. This clamp is required for all ground rod splice connections.

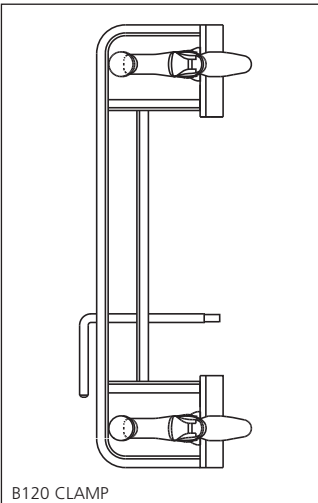

## TIPS FOR MAKING CONNECTIONS

**QUESTION 16:** The CADWELD® catalog states that the average mold life is 50 connections. I can't get anywhere near that many. What can I do to improve my mold life?

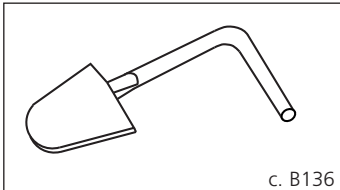

c. B136

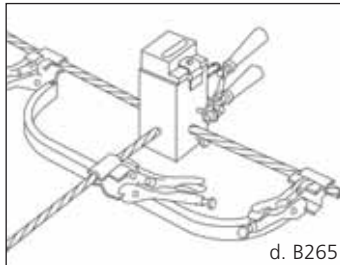

d. B265

**ANSWER:** Mold life will vary to some extent with the type of connection being made. But, 50 connections or more are not unusual for a mold.

- a. One reason for shorter mold life is cleaning the mold with a wire brush. The mold is made of graphite which is a soft material. The wire brush quickly erodes the graphite, resulting in short mold life.
- b. The mold should be cleaned after each connection with a soft cloth, natural bristle brush, crumpled newspaper or a clean rag. Only the loose material must be removed. The mold should never be "scrubbed".
- c. For horizontally split molds (such as **Type TA**), the CADWELD mold cleaning tool (Part No. **B136A** for molds using welding material #65 & smaller, **B136B** for molds using welding material #90 and larger) works quite well without damaging the graphite.  
  
When using horizontally split molds, the tap hole must also be checked when cleaning the mold. If slag remains in the tap hole, push it out with the handle of the mold cleaning tool or with a rod.
- d. The conductors must be aligned before the mold is clamped on. Any misalignment will cause the mold to act as a clamp causing excessive wear and chipping. The cable clamp, Part No. **B265**, helps to properly align the cables.

## TIPS FOR MAKING CONNECTIONS

**QUESTION 17:** I know CADWELD® PLUS does not require the use of starting material, but how is the exothermic reaction started?

**ANSWER:** ERICO® has developed a patented system that initiates the CADWELD® reaction by delivering a specific amount of energy to the welding material using an ignition strip. The strip is constructed of metals and insulation. It is not flammable and cannot spark unless the Control Unit is attached and operated. One of the unique features of this system is that it has the capability of providing a second spark to initiate the reaction if necessary.

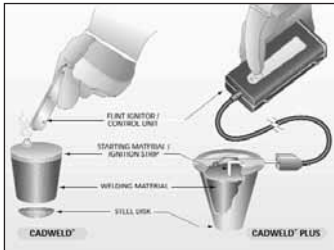

There are a few other tips for using CADWELD® PLUS:

1. The welding material contained within the CADWELD PLUS cup is basically a mixture of copper oxide and aluminum. It is not a bad idea to shake or tap the side of the cup before placing it in the crucible in order to level the powdered material for optimal ignition.
2. Make sure the termination clip is fully engaged; the ignitor strip should be fully inserted into the termination clip to the black line printed on the strip.
3. Hold the operate button on the Control Unit down for the full charge / discharge cycle. Do not let go of the button until the LED is off and the reaction is initiated. Consult the Control Unit Operation Instructions for further details.

**QUESTION 18:** I often have to make taps of small wire from large runs. For instance, #6 tap from a 2/0 run. The Type TA requires that I use a sleeve on the #6. Is this necessary?

**ANSWER:** Yes, it is necessary if you use a Type TA connection. An easier way is to use a **Type PC** connection in which the #6 is parallel to the 2/0. This gives you two advantages:

1. A sleeve is not required.
2. A vertically split mold is used rather than a horizontally split mold which is easier to clean after each connection.

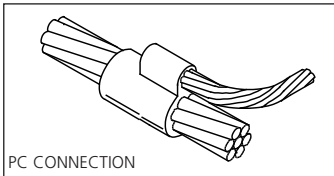

**QUESTION 19:** I have a fine strand cable. It is too large to fit in the mold for that size conductor. What should I do?

**ANSWER:** Ropelay cable (either welding cable or class G or H ropelay) is larger in diameter than concentric cable (7, 19, 37 etc. strand) and therefore a different mold is required. Also, sleeves must be used on the cable ends. The sleeves hold the strands together and give mechanical protection to the strands after the weld is made. Contact ERICO® or your local rep for the proper mold and sleeves.

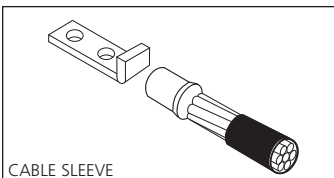



## TIPS FOR MAKING CONNECTIONS

**QUESTION 20:** The last job I was on used #2 solid conductor. The mold I ordered was too big, even though I ordered it for #2. Why?

**ANSWER:** #2 solid is smaller in diameter than #2 stranded. A different mold part number must be ordered. Contact ERICO® or your local rep for assistance.

**QUESTION 21:** I lost my flint ignitor. What else can I use to start the CADWELD® reaction?

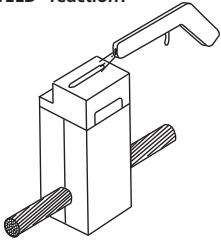

**ANSWER:** Contact your local CADWELD® distributor to buy another one.

Never use any other method including a match, torch, or other hand held flame to ignite starting material. It probably will not start the reaction but if it does, YOU CAN BE BURNED!

NOTE: ERICO now offers a CADWELD system which uses electronic ignition to initiate the reaction. Contact ERICO or your local representative for more information about CADWELD® PLUS.

**QUESTION 22:** My flint ignitors do not last very long. The end of the ignitor gets burned and fouled. How can I avoid this problem?

**ANSWER:** First, make sure you place a small amount of starting material on the welding material in the mold crucible, then place the remaining starting material in the slot on top of the mold cover. The spark is aimed at the starting material in the slot in the baffle to begin the reaction.

Second, stand to the side with the end of the flint ignitor just back from the cover opening when you start the reaction. Now, the end of the flint ignitor is protected from the flame of the CADWELD reaction and should last much longer.

If the end of the flint ignitor becomes fouled, it can be cleaned by soaking it overnight in household ammonia.

**QUESTION 23:** With traditional CADWELD, I use (2) 150s for molds that require 300 grams of welding material and (2) 200s for molds that require 400 grams of welding material. How is that going to be possible with the new system?

**ANSWER:** CADWELD PLUS is available in 300 g and 400 g sizes. The part numbers for the 300 gram size is 300PLUSF20 and the part number for the 400 gram size is 400PLUSF20.

## TIPS FOR MAKING CONNECTIONS

**QUESTION 24:** Rather than buying another mold, I tried to use my Type VS mold to weld a copper plate. The finished weld looked good but when I gave it the hammer test, it came right off. There was almost no penetration into the copper plate. Yet, when I follow the same procedure when welding to a steel surface, I can't knock off the weld. Why?

**ANSWER:** The mold you used was designed and tested for welding to a steel surface. A copper surface is harder to weld to and takes a different mold, which in most cases takes a larger size welding material than steel. Whenever possible, when welding to copper, weld to the edge. Molds for these welds are shown in Section 5 of the CADWELD® E1A catalog.

**QUESTION 25:** My job calls for a 500 kcmil conductor to be welded to a 5/8" copperclad ground rod. Because the conductor is so large, it is difficult to properly position it over the ground rod. Is there an easier way?

**ANSWER:** The easiest way is to make two connections. First, make a TA (TAC3Q2Q) to the 500 using a short length of 4/0 conductor. Then, make a GT (GTCL62Q) of the 4/0 to the ground rod. The installed cost will usually be less than trying to weld the 500 directly to the rod. And electrically, it is just as good.

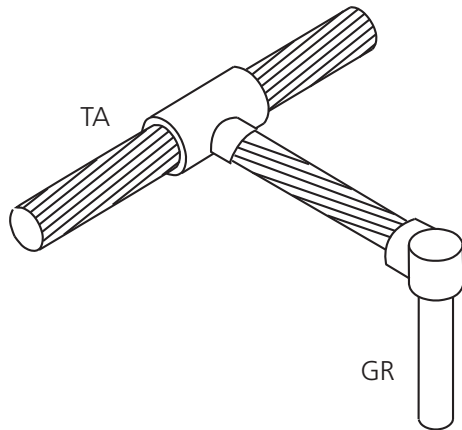

## TIPS FOR MAKING CONNECTIONS

**QUESTION 26:** I have many jobs that require CADWELD® connections to be made indoors near sensitive electronic equipment or outdoors in confined spaces. What can I do to make these connections and not have to worry about smoke created by the welding process?

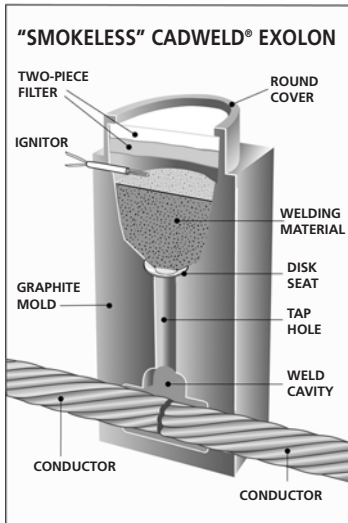

**ANSWER:** To deal with such situations, ERICO® developed the CADWELD® EXOLON low-emission welding process. The CADWELD EXOLON system produces the same permanent, highly reliable welded bonds as the standard CADWELD process, but without the smoke usually associated with the exothermic welding process.

The low-emission CADWELD EXOLON system is ideal for exothermic welding in tunnels, vaults and trenches; and it can be used inside computer rooms, telecommunications centers and other electronic facilities where installers have been reluctant to make CADWELD connections before. That means that exothermic welding can now be used just about anywhere, indoors or out.

The metallurgy is exactly the same as that of the conventional CADWELD connection system, which means the CADWELD EXOLON process still provides a superior connection when compared to compression or bolted connections.

What's different from the standard CADWELD process is that the CADWELD EXOLON system uses a unique, high-temperature dual filter on top of the mold. These filters trap virtually all the smoke created by the welding process, while allowing heated air to escape. In addition, the easy-to-use, battery starting system does away with flint ignitors and open flames.

Any connection listed in the E1A catalog and other catalogs can be supplied using the CADWELD EXOLON process.

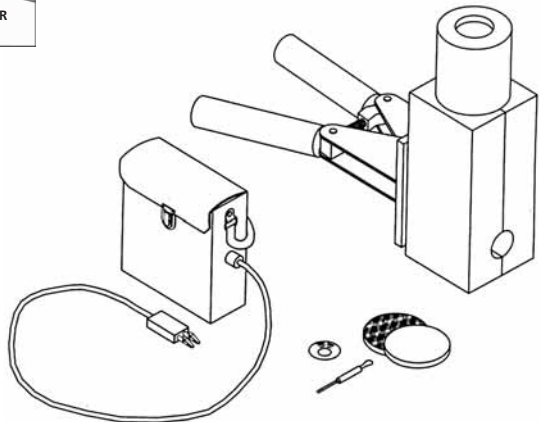

## GENERAL INFORMATION

**QUESTION 27:** I keep hearing the words “price key” in reference to molds. What are they talking about?

**ANSWER:** In order to standardize mold sizes, ERICO® has given each of these standard sizes a letter (price key). For example, the most common molds used for grounding are Price Key “C”.

This Price Key is used to simplify pricing. Rather than individually pricing each and every mold, an average price is established for all molds of the same Price Key. In most cases, the third letter of the mold part number is the Price Key. For example, **TAC2Q2Q** and **GTC162Q** are both Price Key “C”. The exceptions to the third letter rule are CADWELD® EXOLON molds, Heavy Duty (HD) molds and Cathodic (CA) molds.

**QUESTION 28:** I’ve seen some CADWELD® molds with copper plates around the cable openings. What are these for?

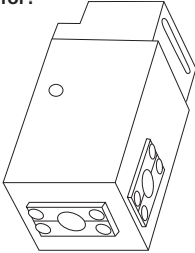

**ANSWER:** These are called wear plates. They are available on most of our molds. Their purpose is to support the cable at the metal plate instead of the soft graphite. This increases the mold life. We have had some contractors tell us the mold life is doubled. You must still treat the mold carefully to get long mold life. Wear plates are available for most CADWELD molds with cable openings from 1/0 thru 500 kcmil and ground rods 1/2” thru 1”. The wear plates can be ordered by adding a “W” suffix to the mold part number eg. **TAC2Q2QW**. Molds with wear plates are not stocked so delivery time will be longer.

**QUESTION 29:** Some of the Type TA molds I get have an extra hinge on the crucible section. Opening this helps in cleaning the mold. What is this called and how do I order it?

**ANSWER:** This is called a “split crucible” feature and is available on most horizontally split molds. To order, add an “L” suffix to the mold part number. For example, **TAC2Q2QL**.

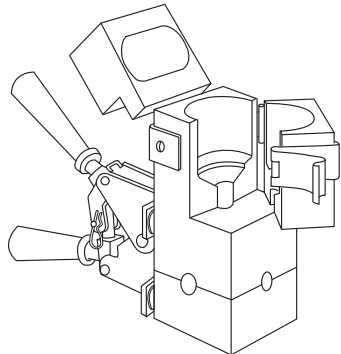

## GENERAL INFORMATION

**QUESTION 30:** I've noticed in your catalog a separate listing for "Heavy Duty" CADWELD® Connections. Why Heavy Duty?

**ANSWER:** Heavy Duty was originally developed by ERICO® after World War II when copper was scarce and the power companies were reclaiming old cotton and tar insulated cable. After burning off the insulation (before EPA restrictions), they found it difficult to properly clean the copper prior to making a connection. We found that by making a connection with two to three times larger size welding material than normally used, we could burn through the "dirt" and make a good connection. Since then, we have modified the welding material size to about 2 sizes larger than standard. Today, Heavy Duty Connections are often used for making connections to aged cable during grounding system expansion projects (for example, expanding the site of a substation grounding grid). When field conditions are unusually bad, CADWELD Heavy Duty connections provide a solution.

**QUESTION 31:** Why are there different color caps on CADWELD welding materials?

COLOR  
CODED  
CAPS

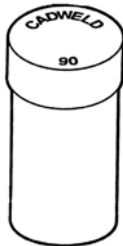

**ANSWER 31a:** The different color caps on CADWELD welding materials indicate different types of CADWELD welding material alloys. We have proven that one type or alloy of welding material is not suitable for all applications. To prevent inferior connections, we have developed the following different types:

- The standard welding material that you normally use will have a clear (or natural) cap. This is used for almost all grounding connections.
- When welding to a cast iron or ductile iron surface, the CADWELD **XF19** alloy is used. These have orange caps.
- When making a grounding connection to a load bearing rail, the CADWELD **F80** alloy is required. These have yellow caps.
- On all cathodic protection jobs, the CADWELD **F33** alloy is utilized. **F33** alloy has green caps. The use of **F33** welding material is absolutely necessary on connections to pipe lines.
- White caps are used for CADWELD® EXOLON welding material which does not contain starting material. See question 26 for more information on this product.

**ANSWER 31b:** CADWELD® PLUS utilizes the same color code as traditional CADWELD, but in the form of a large "dot" on the top of the unit. In addition to the different colors for different alloys, CADWELD PLUS also has a size identification by color on the outer ring to help prevent misapplication of sizes.

## GENERAL INFORMATION

**QUESTION 32:** I lost the label in the welding material box. How can I tell what size welding material I have?

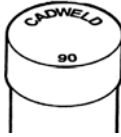

**ANSWER:** The welding material size is embossed on each cap of the individual welding material containers.

**QUESTION 33:** The CADWELD® catalog lists the standard connections of a cable to ground rod, a CADWELD® MINI EZ series and the CADWELD® PLUS ONE SHOT connections. I'm confused as to which one I should use.

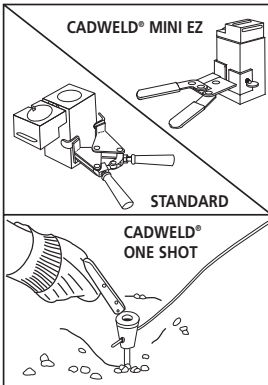

**ANSWER:** Several factors enter into the choice. But, no matter which style is used, you can expect the same high quality CADWELD connection you are used to. When connecting small wire (#4 to #10 AWG) to ground rods, the CADWELD PLUS ONE SHOT and CADWELD MINI EZ styles are less expensive and easier to use than the standard CADWELD. For example, a **GT** connection of #6 to a 5/8" ground rod can be made with a CADWELD PLUS ONE SHOT at a 14 to 18% cost savings as compared to the standard CADWELD. The main advantage of the CADWELD PLUS ONE SHOT is that it's disposable. Where only a few connections are needed at a particular location, the required number of CADWELD PLUS ONE SHOT's can be taken along with a CADWELD PLUS control unit. When finished, nothing has to be carried back and restocked except the control unit. The CADWELD MINI EZ mold style can save up to 45%. However, as the conductor size increases, the savings decrease.

**QUESTION 34:** On connections to reinforcing bar (rebar), a listing for "packing" is noted in the catalog. What is this and do I really need it?

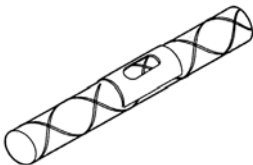

**ANSWER:** YES! It is necessary. The packing listed is a material that is placed around or over the rebar to prevent the molten metal from leaking around the rebar deformations. In some cases, it is a copper shim that is wrapped around the bar and in other cases, it is a ceramic batting material that either wraps around or is placed over the rebar, depending on the connection being made. The instructions enclosed with the mold must be consulted for proper usage of the packing material. Do not substitute any other material for the proper packing. It probably will not work and it may cause a dangerous situation.



## GENERAL INFORMATION

**QUESTION 35: The CADWELD® catalog, in several instances, lists two types of connections for what appears to be the same connection. What is the difference and which should I use?**

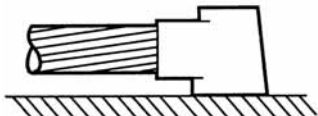

CONDUCTOR OFF SURFACE

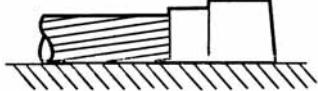

CONDUCTOR ON SURFACE

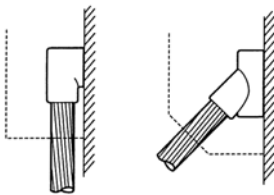

VB

VS

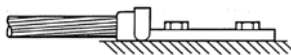

TYPE GL LUG



TYPE LA STRAIGHT LUG



TYPE LA OFFSET LUG

**ANSWER:** Let's look at each of these separately.

- a. **Types HA and HS, Types HC and HT and Types VG and VT.** The difference in these is that one type makes the weld with the cable on the surface of the steel and the other with the cable off the surface. For small conductors, the "on the surface" style is recommended in most cases since the mold is less prone to damage as compared to the "off the surface" mold. But, for conductors 1/0 and larger, the "off the surface" style has the advantage of not having an "open area" around the conductors next to the surface which can leak molten metal unless packed with mold sealer. However, with the "off the surface" style, the mold must be removed from the finished weld more cautiously to prevent the small area of graphite between the mold and the surface from breaking.
- b. Comparing the **Type HA** to the **HB**, the **HA** is for steel surfaces and the **HB** is for cast iron or ductile iron surfaces. Each is designed differently and takes a different welding material alloy. They should never be mixed.
- c. Comparing the **VS** to the **VS Range** and the **HA** to the **HA Range**, the "range" mold is used when connections must be made to more than one pipe size and those sizes fall with the range that the mold fits. Since the mold is made to fit several sizes, care must be exercised when positioning the mold to prevent leakage. When the connection is to be made to only one size pipe, it is better to order the mold for that particular pipe size.
- d. Comparing the **Type VS** to the **Type VB**, the **VS** mold is stronger and will normally have a longer life than the **VB** mold because of the greater mass of graphite around the cable hole. However, some users like the **VB** better because it can result in a neater installation. But, because of the smaller section of mold between the cable and the surface, care must be exercised when using the **VB** mold to prevent this small section from breaking.
- e. Comparing the two types of lug termination molds available, **Types GL and LA**, the **Type GL** is usually more economical. The welding material in most cases is smaller and the lug price is usually less. When comparing the shapes of the two types, it can be seen that the **LA** has two styles of lugs, a straight lug and an offset lug. When bolting to the edge of a surface or another lug, the straight lug can be used. But, when bolting further in from the edge, the weld will interfere with the bolting surface. Then the offset style must be used. The **Type GL** can be used in either situation.
- f. Comparing the **Type XA** to **Type XB**, it is noted that the **XA** requires the tap (usually the smaller) cable to be cut. When using the **XB**, the cables are just lapped and do not require cutting and positioning in the mold. The **XB** mold usually costs more and a larger size welding material is required, but the extra material cost is easily offset by savings in labor.

Also note that when welding a small cable (e.g. #6) to another cable, the #6 requires sleeves. It must be cut to put on the sleeves. Therefore, the **Type XA** mold is the proper choice for this situation.

## GENERAL INFORMATION

**QUESTION 36:** The ERICO® literature states that materials from different manufacturers should not be mixed to perform the CADWELD® connection. But, CADWELD competitors state otherwise. Who is correct?

**ANSWER:** ERICO is correct! CADWELD molds are tested only with CADWELD welding material. There is a great difference between CADWELD welding material and the competitors'. Therefore, ERICO cannot guarantee results if competitors' welding material is used in CADWELD molds.

Mixing and matching ERICO welding materials or molds with those of other manufacturers will void the UL® Listing for safety, and therefore violate NFPA® 70 National Electrical Code®, violate the IEEE® 837 compliance and jeopardize the integrity of the connection. Finally, if you use a competitors' welding material in a CADWELD mold, who do you contact for service or support? Refer to the various welding materials we have for specialized CADWELD applications (See QUESTION 31). We have developed these to provide you with an optimum connection for all your applications.

**QUESTION 37:** Do I need different molds for threaded and pointed ground rods?

**ANSWER:** CADWELD molds used to connect cable to ground rods (GR, GT, NT and ND connections) are designed to work on both threaded and unthreaded ground rods. This is accomplished by adding a "thread clearance" to the weld cavity near the ground rod entrance location of the mold. It is completely acceptable to have a layer of weld metal as a result of the thread clearance below the ground rod sleeve. As this is not part of the cable to rod connection, a void at this location is purely cosmetic and has no effect on the resultant weld or performance of the connection. The disk has been integrated into the CADWELD® PLUS weld metal cup. There is no need to add a separate disk to cover the tap hole.

**QUESTION 38:** The small clip that comes with the mold isn't strong enough to hold the mold together and the weld metal leaks when I make the connection. How can I prevent this from happening?

**ANSWER:** The purpose of these clips is to keep the mold halves together during shipping and handling. They are not designed to hold the mold together during the CADWELD connection process. Molds that are shipped with these clips require a separate handle clamp (either an L160 or L159 depending on the mold price key). See QUESTION 33 for more information on molds, handle clamps, frames and handles.

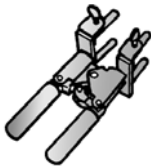



## GENERAL INFORMATION

**QUESTION 39:** There are many different molds and connections, how do I know what frames or handle clamps are required in order to make a connection?

**ANSWER:** For most CADWELD® connections of cable-to-cable, cable-to-lugs, cable-to-steel surfaces, cable-to-ground rods and small busbars, separate handle clamps are required. Although ERICO® has designed tens of thousands of different types of connections worldwide, the vast majority of these molds require the use of one of two different sizes of handle clamps.

These two sizes of handle clamps are:

1. L160 for all molds having a C, E, Q or R price key
2. L159 for all molds having a D, F, J or Z price key

**QUESTION 40:** Are CADWELD Molds for cable-to-ground rods interchangeable for steel and copper rods?

**ANSWER:** No – the diameter of copperbonded and steel rods are different. This difference in diameter requires that molds be drilled for each specific type of rod.

Copperclad rods are actually noted as a nominal dimension. This measurement is actually less than the steel diameter. For example, the nominal dimension of a 3/4" copperbonded rod is actually 0.682" – or 0.068" less than its stated size. Steel rods (stainless and galvanized manufactured in accordance to the NEMA® standard) are actually full sized. Therefore, a 3/4" steel rod is actually 0.750" in diameter.

Please see the following chart for further information

Nominal Size	Material	Type	Thread Size	Rod Diameter	CADWELD Ground Rod Code
1/2"	Copperbonded	Sectional	9/16"	0.505	14
	Steel*	Plain		0.500	14
	Copperbonded	Plain		0.475	15
	Copperbonded	Sectional		1/2"	0.447
5/8"	Copperbonded	Sectional	5/8"	0.563	16
	Steel*	Plain		0.625	31
	Copperbonded	Plain		0.563	16
3/4"	Copperbonded	Sectional	3/4"	0.682	18
	Steel*	Plain		0.750	33
	Copperbonded	Plain		0.682	18
1"	Copperbonded	Sectional	1"	0.914	22
	Steel*	Plain		1.000	37
	Copperbonded	Plain		0.914	22

\* Plain steel, stainless steel, stainless clad rods or galvanized steel rods manufactured in accordance with NEMA GR-1.

# INDEX

	QUESTION #	PAGE #
<b>Adaptor Sleeve</b>	1	5
<b>Cable</b>		
Burned Up	9	11
Clamp	9	11
Concentric Strand	20	17
Fine Strand	20	17
Melting	9	11
Position	13	13
Ropelay	20	17
<b>Caps, Color Coded</b>	31	21
<b>Clamp</b>		
B120	15	14
Cable	9	11
Handle	11	12
Magnetic	13	13
Vertical Pipe	13	13
Vertical Support	13	13
<b>Conductor</b>	12	12
Cleaning	4	9
Proper Position	25	18
Solid	20	17
Stranded	20	17
<b>Connection</b>		
Confined Spaces	26	19
Copper	24	18
CADWELD® EXOLON	26	19
Grounding	33	22
Heavy Duty	30	21
Inside	26	19
CADWELD® MINI EZ	33	22
CADWELD® PLUS ONE SHOT	33	22
Parallel	3	7
Rebar	34	22
Smokeless	26	19
Standard	33	22
Steel	24	18
X	2,3	6,7
<b>Contamination</b>	5	9
<b>Crucible, Split</b>	29	20
<b>Driving Sleeve</b>	14	14
<b>CADWELD EXOLON</b>	26	19
<b>File</b>	12	12

	QUESTION #	PAGE #
<b>Flint Ignitor</b>	21	17
Burned	22	17
Cleaning	22	17
Fouled	22	17
<b>Graphite</b>	17	16
<b>Grinder</b>	12	12
<b>Ground Rod</b>	14	14
Connections	3	7, 8
Copperclad	25	18
Position	15	14
<b>Ground Rod Splice</b>		
Type GB	15	14
<b>Ground Rod Driver</b>		
ERITECH®	14	14
<b>Handles</b>	11	12
<b>Heavy Duty Connection</b>	30	21
<b>Inventory, Reduce</b>	3	7, 8
<b>Lugs</b>	18	16
<b>CADWELD MINI EZ</b>	33	22
<b>Moisture</b>	6, 7	9
Conductors	7	9
Remove From Mold	7	9
<b>Mold Sealer</b>	9, 10	11
<b>Mold type</b>		
GB	16	15
GL	10, 36	11, 24
GT	3, 25	7, 18
GY	2, 3	6, 9
HA	36	24
HB	36	24
HC	3, 36	7, 24
HS	36	24
HT	3, 36	7, 24
LA	18, 36	16, 24
ND	3	7
PC	19	16
PT	3	7



# INDEX (Cont.)

	QUESTION #	PAGE #		QUESTION #	PAGE #
<b>Mold type (cont.)</b>					
TA	3, 17, 19, 25	7, 16, 18	I beam	14	14
VB	36	24	Flat	14	14
VG	3, 36	7, 24	Galvanized	13	13
VS	24, 36	18, 24	Horizontal	3	7, 8
VT	3, 36	7, 24	Mold Attachment	14	14
VV	2	6	Preparation	13	13
XA	3, 36	7, 24	Vertical	3	7, 8
XB	3, 36	7, 24	Vertical Pipe	14	14
<b>Mold</b>			<b>Surface, Galvanized</b>	5	9
Attachment To			<b>T Connections</b>	3	7, 8
Steel Surface	14	14	<b>Taps, Small Wire</b>	19	16
Cleaning	17	16	<b>Torch, Alternative</b>	8	10
Cleaning Tool	17	16	<b>Vertical Cable</b>	3	7, 8
Close	12	12	<b>Welding Material</b>		
Extending Life	17, 28	16, 20	Different Manufacturer	37	24
Heating	8	10	Mixing	37	24
Horizontally Split	17, 29	16, 20	<b>Welding Material</b>	9	11
Life	17	16	CADWELD &		
Misalignment	17	16	CADWELD® EXOLON	31	21
Off The Surface	36	24	Color Coded Caps	31	21
On The Surface	36	24	Correct Size	23	17
Parting Line	12	12	F33 Alloy	31	21
Standard Size	27	20	Leakage	9, 10	11
Wear Plates	28	20	Size	32	22
With Copper Plates	28	20	Standard	31	21
<b>Oil</b>	5	9	XF19 alloy	31	21
<b>CADWELD® PLUS ONE SHOT</b>	34	22	<b>Wrap Sleeve</b>	1	5
<b>Packing</b>	35	23			
<b>Price Key, Explanation</b>	27	20			
<b>Rasp</b>	13	13			
<b>Reaction, CADWELD®</b>	22	17			
<b>Rebar</b>	35	23			
<b>Riser, Holes</b>	5, 6	9			
<b>Shim</b>	1, 35	5, 23			
<b>Sleeve</b>	19, 20	16, 17			
<b>Splice Connections</b>	3	7, 8			
<b>Steel Surface</b>	13	13			

# Consult the following documents for further information:

## CADWELD® Welded Electrical Connections Catalog CADWELD® Field Catalog Installers & Inspectors Guide

### WARNING:

1. These products shall be used only as illustrated and recommended in product instruction sheets (instruction sheets are available at [www.ericco.com](http://www.ericco.com)). Improper installation, misuse, or misapplication may result in possible property damage or bodily injury.
2. These products must be used only in the manner depicted in the illustrations that accompany them.
3. Failure to observe these instructions may cause product malfunction, property damage, and bodily injury. ERICO products are warranted to conform, at the time of shipment, to any applicable written description furnished to the Buyer by ERICO, and to be free from defects in material and workmanship. NO OTHER WARRANTY, WHETHER EXPRESS OR IMPLIED, (INCLUDING ANY WARRANTY OF MERCHANTABILITY, FITNESS FOR A PARTICULAR PURPOSE, OR INFRINGEMENT), SHALL EXIST IN CONNECTION WITH THE SALE OR USE OF ANY ERICO PRODUCT.
4. All instructions must be completely followed to ensure proper and safe operation.

### GENERAL AND SAFETY INSTRUCTIONS:

- A. Only ERICO manufactured equipment and materials should be used to make CADWELD/CADWELD PLUS connections.
- B. Do not connect items except as detailed in instruction sheets. Failure to comply with these instructions may result in improper and unsafe connections, damage to items being connected, bodily injury and property damage.
- C. Do not use worn or broken equipment which could cause leakage.
- D. Do not alter equipment or material without ERICO authorization.
- E. When using CADWELD/CADWELD PLUS do not use welding material package if damaged or not fully intact. When using CADWELD PLUS, do not tamper with or disassemble the welding material unit.
- F. Make connections in conformance with CADWELD/CADWELD PLUS instructions and all governing codes.
  1. Personnel should be properly trained in the use of this product and must wear safety glasses and gloves.
  2. Avoid contact with hot materials.
  3. Advise nearby personnel of welding operations in the area.
  4. Remove or protect fire hazards in the immediate area.
  5. Provide adequate ventilation to the work area.
  6. Do not smoke when handling starting material.
  7. Avoid direct eye contact with "flash" of light from ignition of starting material.
- G. Welding material is an exothermic mixture and reacts to produce hot molten material with temperatures in excess of 1400°C (2500°F) and a localized release of smoke. These materials are not explosive. Ignition temperatures are in excess of 900°C (1650°F) for welding material.
- H. Adhering to the CADWELD/CADWELD PLUS welding procedures will minimize risk of burns and fire caused by hot molten material spillage. In case of fire, use of water or CO<sub>2</sub> will aid in control of burning containers. Large quantities of water will aid in controlling a fire should the exothermic materials become involved. Water should be applied from a distance.
  1. Make sure there is proper mold fit and assembly of equipment.
  2. Avoid moisture and contaminants in mold and materials being welded. Contact between hot molten metal and moisture or contaminants may result in spewing of hot material.
  3. Base material thickness must be sufficient for the size and type of connection being made to prevent melt-through and leakage of hot molten metal.
- I. Applications or conditions may exist which require special considerations. The following are examples, but are not intended to be a complete listing of applications/conditions.

### CONNECTIONS TO PIPE/VESSELS

For use with cast iron pipe or heavy casting meeting ASTM A47-84, A48-83, A126-84, A278-85, or A377-89. DO NOT USE ON CAST IRON SOIL PIPE (ASTM A74-93). Evaluate possible effects of CADWELD/CADWELD PLUS connections to structural members and thin-wall materials, vessels/piping systems that are pressurized, closed or containing (or having contained) flammable / explosive / hazardous materials. Evaluation should be made prior to use, based on conditions of use and applicable codes, and should incorporate as a minimum, effects of melt-through of hot material; structural/metallurgical effects of CADWELD/CADWELD PLUS connections, pressure (temperature) build-up and fire/chemical decomposition hazards.

### CONNECTIONS TO REBAR

Application of the CADWELD/CADWELD PLUS connection may have an effect on the rebar's structural integrity. The rebar's chemistry and the location of the weld should be considered before making any welds to the rebar. For lapped rebar splices, it is recommended that the connections be made near the bar end at an area of minimum stress. If CADWELD/CADWELD PLUS Rebar Splices are used, the grounding connection can be made to the splice sleeve with minimal effect on the structural characteristics of the splice.

### SAFETY WARNING:

SAFETY INSTRUCTIONS: All governing codes and regulations and those required by the job site must be observed. Always use appropriate safety equipment such as eye protection, hard hat, and gloves as appropriate to the application.

### WARRANTY

ERICO products are warranted to be free from defects in material and workmanship at the time of shipment. NO OTHER WARRANTY, WHETHER EXPRESS OR IMPLIED (INCLUDING ANY WARRANTY OF MERCHANTABILITY OR FITNESS FOR A PARTICULAR PURPOSE), SHALL EXIST IN CONNECTION WITH THE SALE OR USE OF ANY ERICO PRODUCTS. Claims for errors, shortages, defects or nonconformities ascertainable upon inspection must be made in writing within 5 days after Buyer's receipt of products. All other claims must be made in writing to ERICO within 6 months from the date of shipment or transport. Products claimed to be nonconforming or defective must, upon ERICO's prior written approval in accordance with its standard terms and procedures governing returns, promptly be returned to ERICO for inspection. Claims not made as provided above and within the applicable time period will be barred. ERICO shall in no event be responsible if the products have not been stored or used in accordance with its specifications and recommended procedures. ERICO will, at its option, either repair or replace nonconforming or defective products for which it is responsible or return the purchase price to the Buyer. THE FOREGOING STATES BUYER'S EXCLUSIVE REMEDY FOR ANY BREACH OF ERICO WARRANTY AND FOR ANY CLAIM, WHETHER SOUNDING IN CONTRACT, TORT OR NEGLIGENCE, FOR LOSS OR INJURY CAUSED BY THE SALE OR USE OF ANY PRODUCT.

### LIMITATION OF LIABILITY

ERICO excludes all liability except such liability that is directly attributable to the willful or gross negligence of ERICO's employees. Should ERICO be held liable its liability shall in no event exceed the total purchase price of the product. ERICO SHALL IN NO EVENT BE RESPONSIBLE FOR ANY LOSS OF BUSINESS OR PROFITS, DOWNTIME OR DELAY, LABOR, REPAIR OR MATERIAL COSTS OR ANY SIMILAR OR DISSIMILAR CONSEQUENTIAL LOSS OR DAMAGE INCURRED BY BUYER.

IEEE is a registered trademark of The Institute of Electrical and Electronics Engineers, Inc.

NEC is a registered trademark of National Fire Protection Association, Inc.

NEMA is a registered trademark of National Electrical Manufacturers Association.

NFPA is a registered trademark of National Fire Protection Association.

UL is a registered trademark of Underwriters Laboratories, Inc.

Copyright ©2006 ERICO International Corporation. All rights reserved.

CADDY, CADWELD, CRITEC, ERICO, ERIFLEX, ERITECH, and LENTON are registered trademarks of ERICO International Corporation.

USA/Canada ph: 1-800-677-9089 fax: 1-800-677-8131

Chile ph: 562-624-4004 fax: 562-624-4006

Brazil ph: 55-11-3621-4111 fax: 55-11-3621-7425

Mexico ph: 525-260-5991 fax: 525-260-3310

[www.ericco.com](http://www.ericco.com)

The ERICO logo features the word "ERICO" in a bold, italicized, sans-serif font. The letters are black with a white outline, giving it a three-dimensional appearance. The logo is positioned in the bottom right corner of the page.

ERE E1172108NAEN 00710M8